

# CONTINUOUS LINEAR



MADE  
RIGHT  
HERE®

# CONTINUOUS LIGHT ENDLESS DESIGN

The Williams extensive suite of continuous lighting solutions is designed to provide uninterrupted, low-glare illumination while enhancing the architecture of any space.

- Maximize energy savings with products sporting efficacies as high as 125 lm/W
- Simplify layout design and quickly order with the Williams Linear Product Builder
- Choose from ambient, perimeter and cove styles to create elegant, modern spaces
- Enable smart building integration with PoE controls
- Create rich environments with Tunable White and Tunable Color

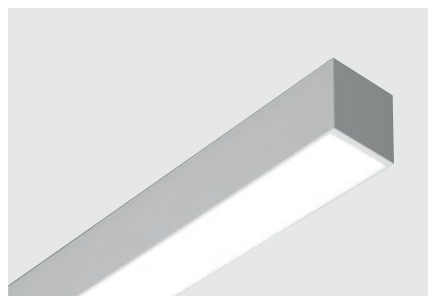

MX | Ambient

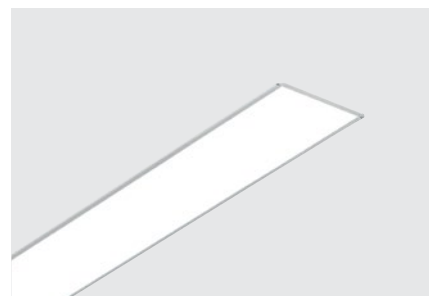

LRX | Recessed



PX | Perimeter



CX | Cove





## LINEAR PRODUCT BUILDER

Our powerful software tool enables you to quickly layout continuous linear projects and streamline the ordering process. The simple and intuitive user interface is designed for three simple steps:

### Step 1: Choose A Shape



From stand-alone, straight rows to long runs, squares and corners, select a shape to start customizing your project.

### Step 2: Specify The Length

Available in inch increments for a tailored fit, enter the total length needed for each run of your project.

### Step 3: Finalize Your Design

Swap lenses, color temperature, and lumen output. Add emergency battery options or a custom finish, then press the save button to share the project or retrieve your design later.

# MX AMBIENT

The power of light and architecture combine to create polished, contemporary spaces with the Williams MX system. The 2" and 4" narrow apertures provide smooth, seamless illumination with high-performing, energy-saving LEDs. Imagination has no limits, with recessed, surface, suspended, wall, recessed wall, and corner mounting, a cohesive – yet unique – design has never been easier.

## Lenses

### MX4



FLAT



PROUD



REGRESSED



### MX2



FLAT



GLOWING EDGE



DROP



REGRESSED



# MX STYLES

## Recessed

Available with trim or trimless, the recessed system is designed for grid, drywall, in-wall, or any other material up to 2" thick.



## Suspended

Illuminate spaces with up, down, or up/down configurations. Movable hardware easily slides along the length of the fixture providing variable mounting points for a clean and simple installation.



## Surface | Wall Mount

Highlight architectural details and create task light for work spaces with wall mount. For lower ceiling heights, surface mount provides standalone, row mount, and horizontal corner styles.

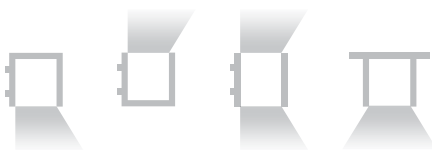

BG Products | Wichita, KS  
Architect: SJCF Architecture  
Photographer: Essential Images Photography | Milt Mounts

## Corner Configurations



HORIZONTAL

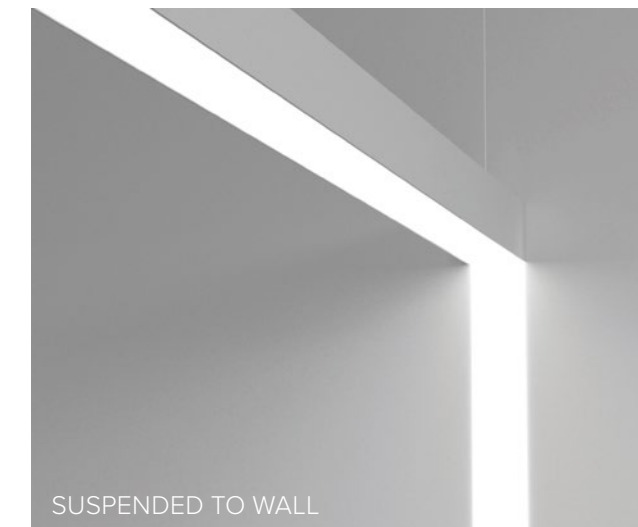

SUSPENDED TO WALL

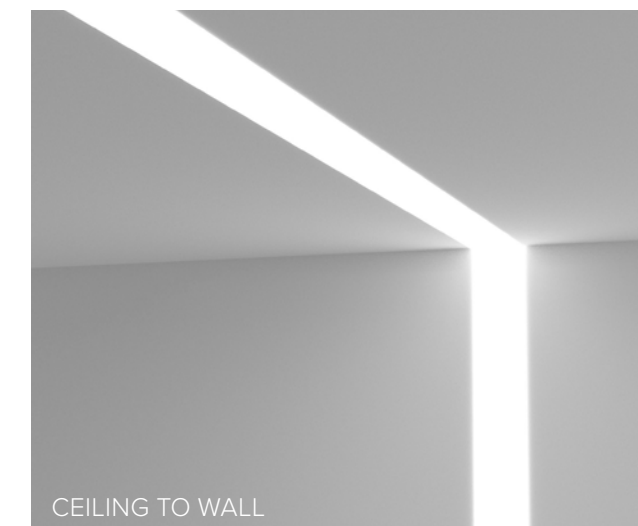

CEILING TO WALL

# LRX RECESSED

Build within budget with Williams recessed linear luminaire, providing high-performance, seamless illumination at an unbeatable value.

- Grid or hardpan ceilings
- Lift and shift lens for simple installation
- Stand-alone or continuous straight rows
- Shorter lead times

## Four Sizes

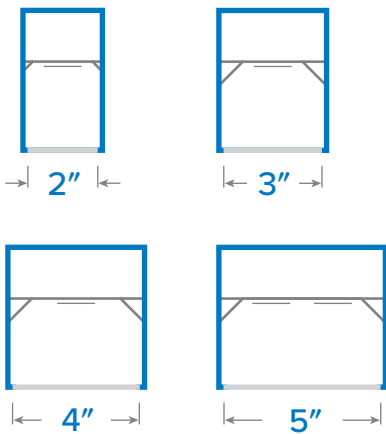

# PX PERIMETER WALL

Enhance architectural details with three distinct distributions for precise perimeter lighting. The Williams PX system is engineered to provide seamless illumination with field-adjustable extensions to ensure a perfect fit in continuous runs and around corners.

## 6 Sizes

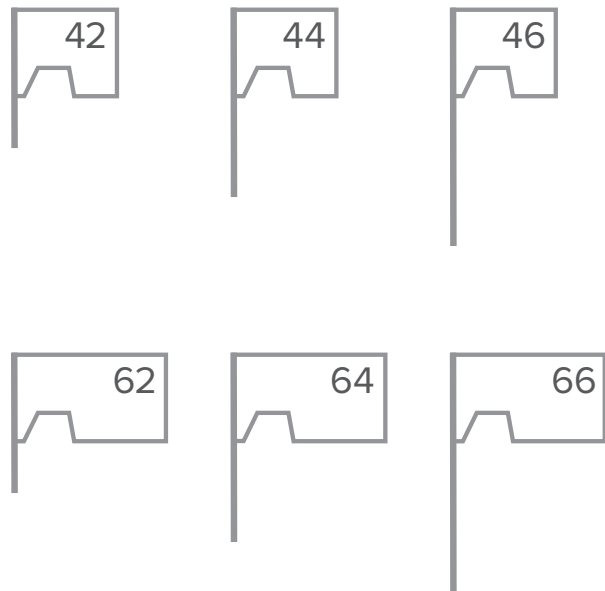

# PX FEATURES

- Wash distribution allows for 90° run connections in both inside and outside corners
- Fast and easy installation with a quick-hang feature
- Solutions for both grid and drywall ceilings
- Multiple size options provide a tailored fit for the application

## Distributions



### Graze

Dramatically highlight accent walls and emphasize textured surfaces

### Wash

Subtly illuminates walls while providing low-glare ambient illumination

### Slot

Wide asymmetric distribution produces ample general illumination in high-ceiling environments





# CX COVE

Designed for uniform indirect lighting and field-adjustable to the inch, the Williams CX provides cove lighting at an exceptional value. Create seamless dramatic effects with soft, glare-free illumination.

- Engineered for contractor and extruded covers
- Tailored accent lighting with 0° and 25° distributions
- Ensure a perfect fit around corners and eliminate dark spots
- Various control options and integral emergency
- Quick-connect wiring for simple, lay-in installation

## Extended Channel



## Distributions



# HUMAN-CENTRIC LIGHTING

## Tunable Color

Create rich, vibrant designs with lasting visual impact using the full visible light spectrum to accent architectural elements in lobbies, energize the mood at event venues, and highlight displays in retail spaces.

## Tunable White

Support human-centric design through adaptive, individualized lighting using tunable white light to promote wellness in healthcare facilities, enhance concentration in classrooms, and improve productivity in workspaces.



Williams and BIOS have partnered to bring you state-of-the-art LED white light circadian solutions in high-performance luminaires.



NeoCity Office Building | Kissimmee, FL  
Architect: SchenkelShultz Architecture  
Photographer: Chad Baumer Photography

# LIGHTING CONTROLS

## Bluetooth® Lighting Controls

Gateway-free technology from Avi-on plus integrated fixture controls from Williams combine to deliver a turnkey solution that makes commissioning and setup a breeze.



## Data-Driven Systems

With over 80 PoE-enabled luminaires, environmental sensors, and software packages, Platformatics provides an IoT lighting backbone for healthy, smart buildings.



## In-Fixture Solutions

Through our partnerships with industry leaders, we bring sophisticated lighting controls and specification-grade LED luminaires together to enhance user experiences in the built environment.





**H.E. WILLIAMS, INC.**

831 West Fairview Ave | Carthage, MO 64836

417-358-4065

[hew.com](http://hew.com)